

# ORION

## SERIES



---

## TABLE OF CONTENTS

---

	Page No.
Orion Diagram	2
Wind Resistance and Guidelines	3
Installation Guidelines	3
Assembly Instructions	4
Operating Instructions	8
How to Properly Fold Canopy	10
Protective Cover	10
Canopy Structure Removal	11
Canopy Removal and Replacement	11
Maintenance	12
Safety and Precautions	12
Warranty	13

**Please read this entire manual before installing or operating your umbrella.**

Thank you for purchasing Shademaker's Orion side post umbrella. Please remove all contents from packaging, inspect and review diagram.

*Some parts may be included in the Styrofoam packaging. Do not discard any packaging or box until assembly is complete.*

**ORION DIAGRAM**

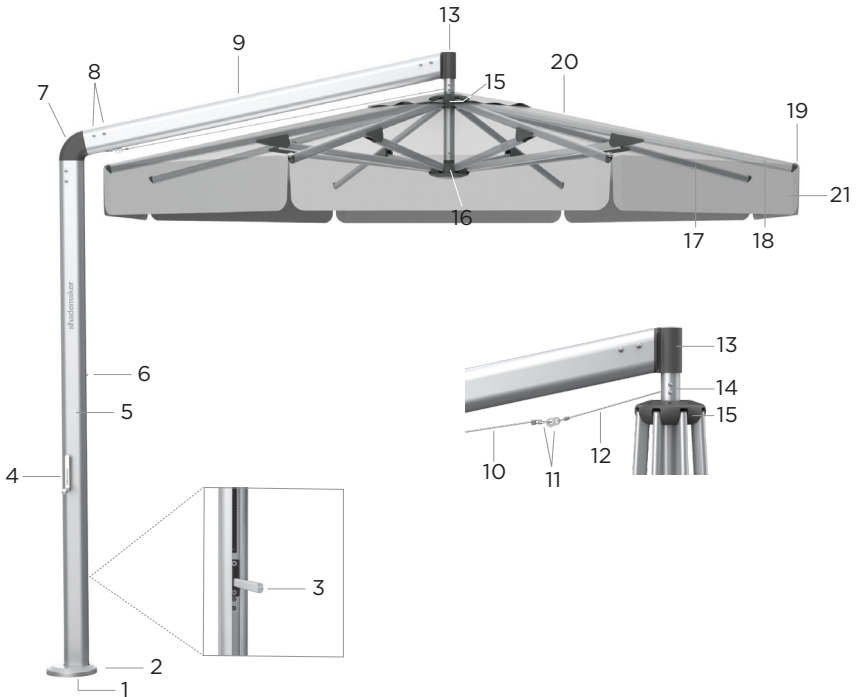

- 1. Internal Stem (not shown)
- 2. Internal Stem Cover (optional)
- 3. Turning Handle
- 4. Crank Handle
- 5. Mast
- 6. Safety Bolt for Sister Clip
- 7. Elbow
- 8. Fastening Screws
- 9. Boom
- 10. Cord
- 11. Sister Clips
- 12. Stainless Wire
- 13. Head Fitting
- 14. Canopy Structure Pole
- 15. Upper Hub Assembly
- 16. Lower Hub Assembly
- 17. Short Rib Assembly (square only)
- 18. Long Rib Assembly
- 19. Locking Canopy Fastener
- 20. Canopy
- 21. Valance (optional)
- 22. Canopy Strap (not shown)
- 23. Protective Cover (not shown)

---

## IMPORTANT

### WIND RESISTANCE GUIDELINES:

#### Moderate Wind

When installed properly using a mount kit, the umbrella is engineered to handle moderate wind conditions in the open canopy position. Please adhere to these wind guidelines:

1. As winds get stronger or, in anticipation of uncertain/severe weather conditions, the canopy should be lowered to the folded and strapped position.
2. The Orion should always be left in the folded and strapped position when unattended or not in use.
3. In anticipation of, and during extremely severe weather conditions, it is advisable to remove and store the entire umbrella structure to protect it from storm-related debris.

**NOTE:** Wind resistance should only be used as a guideline. Wind is not covered by warranty. See page 14 for more information.

---

## INSTALLATION GUIDELINES

Depending on your installation, you will have purchased a mount kit or free-standing base at the time of your order. For free-standing base applications, it is imperative to purchase the appropriate base for your umbrella. The minimum base weight required for each size is:

- ORI-30 is 300 lbs.
- ORI-30S is 350 lbs.
- ORI-40 is 500 lbs.

**NOTE:** If using a free-standing base, wind guidelines change to light winds only.

Using a Shademaker mount kit is always the preferred method of securing your umbrella above all other methods. We recommend a licensed contractor to secure your Shademaker umbrellas.

**NOTE: REFER TO SEPARATE MANUAL FOR MOUNT KIT/BASE ASSEMBLY PRIOR TO PROCEEDING.**

## ASSEMBLY INSTRUCTIONS

**Two-person team is recommended for assembly.**

By now, you have installed your mount kit or free-standing base, with the required minimum base weight.

### Assembling Boom to Mast

1. Unpack the Orion and lay it out on a clean, soft surface.
2. Slide the boom over the elbow and secure with 2 supplied fastening screws with a 5mm hexagon wrench.



**NOTE:** Be careful to not knick the cord. Do not use power drill. May cause damage to umbrella.

### Installing Internal Stem

**Option A: If you wish to use optional pre-installed internal stem cover, proceed below. Otherwise, if you wish to not use internal stem cover, skip to Option B on page 5.**

#### OPTION A:

1. Using a two person team, lift umbrella with attached internal stem and stem cover, and install internal stem onto mount kit or on your free-standing base.
2. Tighten 4 stem bolts to secure umbrella in place with 5mm hexagon wrench.
3. Slide internal stem cover down to cover internal stem.

**NOTE:** Do not use power drill. May cause damage to umbrella.

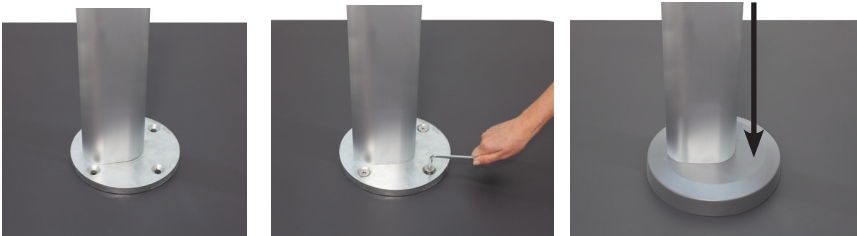

*Proceed to "Attaching Canopy Structure to Head Fitting" on page 7.*

**OPTION B: If you wish not to use optional internal stem cover, proceed below.**

1. With your umbrella laying on a clean soft surface, remove internal stem from bottom of mast by removing the (3) turning handle bolts underneath the turning handle. **NOTE: Do not** remove the bolt above the turning handle!
2. Install internal stem onto mount kit or free-standing base with supplied 4 stem bolts. Tighten with provided 5mm hexagon wrench to secure.

**NOTE:** Do not use power drill. May cause damage to umbrella.

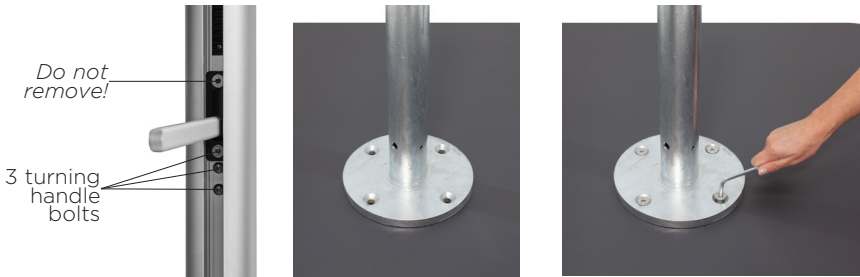

3. Remove internal stem cover from bottom of umbrella mast.
4. Using a two person team, lift umbrella and insert bottom of mast onto internal stem.

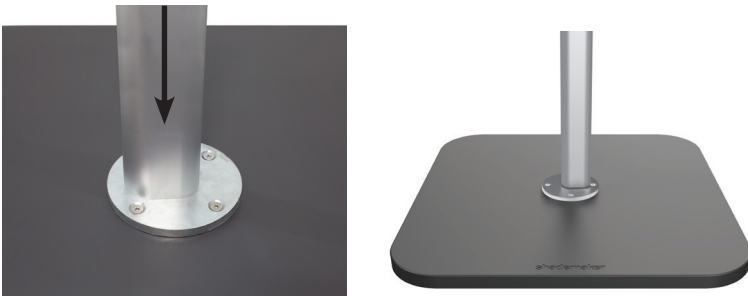

## Attach Mast to Internal Stem

1. Lift rotating handle from mast.
2. Rotate umbrella mast until the bore holes for the turning handle bolts in the internal stem line up in the mast.
3. Insert (3) turning handle bolts into mast and internal stem. Tighten with 5mm hexagon wrench to secure.

**NOTE:** Do not use power drill. May cause damage to umbrella.

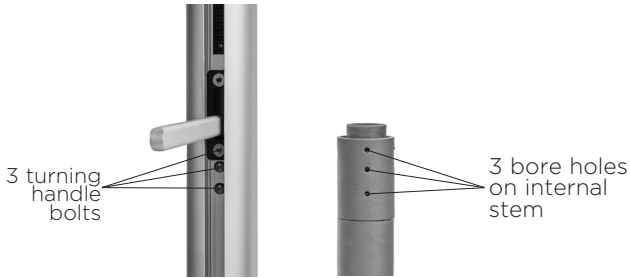

## Attaching Canopy Structure to Head Fitting

1. Lift canopy structure and connect sister clip on the canopy structure to the clip on the stainless wire.
2. Slide the canopy structure into the head fitting by aligning the set screw on the top of the canopy structure with the slot in the head fitting. May need to loosen cord. Turn 90° and secure.
3. Gently lower canopy structure until set screw latches.

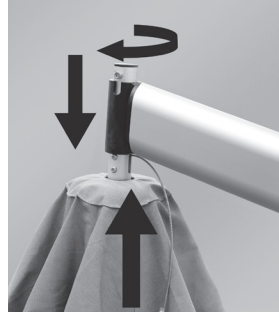
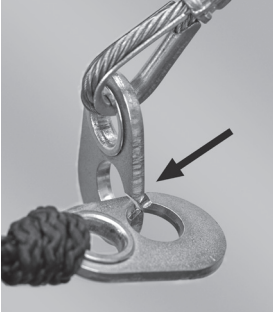

Sister Clips



*You are now ready to operate your umbrella!*



## OPERATING INSTRUCTIONS

Remove all packaging from umbrella and umbrella parts.

### To Open Canopy

1. Remove the strap from canopy structure. Take note of the “parachute” folding method used to fold the canopy when closed. See TO PROPERLY FOLD CANOPY section on page 10 for more details.
2. Slightly loosen ribs. **CAUTION: NEVER FORCE THE RIBS.** If you experience any resistance, make sure all ribs are freed manually to facilitate opening.
3. Insert crank handle into crank gear on mast.
4. Turn crank handle clockwise until canopy is taut.



## To Rotate 360°

### **IMPORTANT: PRIOR TO USING ROTATION FEATURE.**

To avoid personal injury or damage to the umbrella, make sure the umbrella is in a horizontal position and the area behind you is clear and free from any furniture or structure.

1. There are (8) 45° locking rotating positions. Raise the turning handle above 90° and rotate mast to one of the 8 preset positions.
2. Lower handle to lock into place.

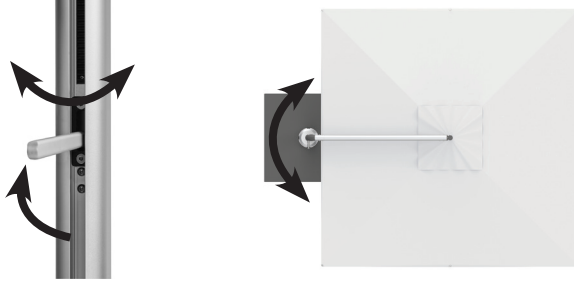

## To Close Canopy

1. Insert crank handle into crank gear on mast. Turn crank handle counter-clockwise until umbrella is completely closed.
2. Wrap supplied strap around canopy to secure. **NOTE:** When fastening strap, make sure that no fabric is caught in between the ribs, as this can result in rubbing and damage to the canopy.
3. Use provided protective cover to protect your fabric and prolong the life of the canopy.



Closed Position

---

## TO PROPERLY FOLD CANOPY

---

The 100% solution dyed canopy will last longer if you fold it as it was packed and shipped. This technique is similar to the way a parachute is folded and is especially important when folding the canopy for seasonal storage or when left in the closed position for an extended period of time.

Using this technique at all times will significantly extend the life of the canopy.

1. When the canopy has been fully lowered, stand in front of the canopy structure and begin the folding process by pulling out two panels opposite the mast. Pull the two panels together and roll tight into the canopy.
2. Once rolled tight, pull adjacent panels out one at a time and fold to the center, alternating sides until all the panels have been pulled out from the arms and folded into the center.
3. Wrap provided strap around canopy to secure.

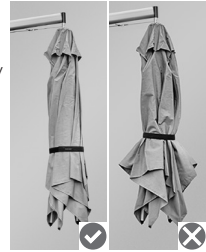

---

## PROTECTIVE COVER

---

1. Screw rods together and insert into slit of the cover.
2. Unzip cover.
3. Using the rod as a guide, slide cover over your umbrella.
4. Attach rod with key ring to the zipper.
5. Pull on string to zip down your cover and tie to secure.



## CANOPY STRUCTURE REMOVAL

In anticipation of, and during extremely severe weather conditions, it is advisable to remove and store the entire umbrella structure to protect it from storm-related debris.

1. Lower the canopy to the closed position.
2. Disconnect sister clips on canopy structure from the clip on stainless wire.
3. Turn canopy structure 90° and slide out of head fitting.
4. Store away canopy structure.
5. Secure loose end of sister clip to sister clip safety stud located on mast.

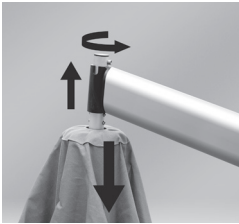

Sister Clip on Safety Stud

## CANOPY REMOVAL & REPLACEMENT

Follow these instructions should you choose to replace your canopy with a new canopy.

1. With umbrella in the open position, separate the (4) Velcro straps from ribs underneath umbrella.
2. Lower the canopy to the closed position.
3. Remove the locking canopy fastener at the end of each long rib.
4. Disconnect sister clips on canopy structure from the clip on stainless wire.
5. Turn canopy structure 90° and slide out of head fitting.
6. Lay canopy structure on clean, soft surface.
7. Separate the Velcro strap near upper hub and slide canopy off the canopy structure.
8. To replace the canopy, reverse the above process.

---

## MAINTAINING FRAME & FITTINGS

- Hose frame with water periodically, more often if installation is in a salty or industrial environment.
- Inspect the installation fitting, mount bolts, rib spacers, etc. on a regular basis and tighten if necessary.

---

## MAINTAINING CANOPY FABRIC

- Clean up spills and stains right away. Spills can be removed by using a clean absorbent cloth.
- For general maintenance, use a soft brush to remove dust and dry soil. Wash down with clean, warm water (i.e., garden hose) every so often to avoid dirt becoming ingrained. Allow the fabric to air dry before closing the canopy.
- If a thorough cleaning is necessary, sponge over the fabric using a mild soap solution (2% solution). Rinse well with plenty of water to remove all soap residue.
- Never use detergents, cleaning fluids or solvents. Grease and oil stains may be removed by using turpentine or similar with an absorbent cloth.
- Please visit the fabric websites for more details: [www.sunbrella.com](http://www.sunbrella.com), [www.obravia.com](http://www.obravia.com), or [www.outdura.com](http://www.outdura.com)
- Use protective canopy cover during storage or when not in use.

---

## SAFETY AND PRECAUTIONS

- To reduce risk of personal injury in which a person is injured or harmed, and/or damage to personal property, read and follow the Owner's Manual prior to assembling and operating umbrella and base.
- Close and store the umbrella in windy conditions or when a storm approaches. Never allow the umbrella to flap in the wind; this could cause personal injury, damage to personal property, damage to umbrella and/or umbrella canopy.
- Keep umbrella secured to umbrella base at all times.
- Do not leave open umbrella unattended. If damage occurs, this is not covered by the warranty.
- When adjusting the umbrella, make sure that no person(s), item(s) or personal property are close to the umbrella. This is important to prevent injury or material damage.
- Do not allow children to play on or with umbrella or umbrella base.
- When adjusting or assembling the umbrella or umbrella base, make sure fingers, toes or any other parts of the body are clear from moving parts. Failing to do so may result in serious injury.
- Sufficient base weight must be used to secure umbrellas at all times. Please base weight matrix at [www.shademakerusa.com](http://www.shademakerusa.com) for required minimum weight for free-standing applications. Using a Shademaker mount kit is always the preferred method of securing your umbrella above all other methods. We recommend a licensed contractor to secure your Shademaker umbrellas.

## WARRANTY

Shademaker manufactures all its shade styles from the finest aluminum alloys to ensure the strength, durability, and integrity of each and every style. We pride ourselves as a totally vertical operation. This means that we manufacture and produce over 90% of the components used in our products from the raw state. We can monitor every stage of the manufacturing process and maintain a consistent level of quality. Our only business and focus is shade and shade type products. Our goal is that each and every Shademaker style will exceed your expectations at a competitive price that will make you smile.

Replacement parts can be ordered under warranty at no charge, if found that the damage is a manufacture defect.

Upon receipt, please check to ensure you have received all of the parts.

### 10 Year Limited Warranty

- Mast, boom, head fitting, elbow, ribs, upper and lower hub, and stainless steel hardware.

### 5 Year Limited Warranty

- Frame finishes, including powder coated.
- Lift system components, including crank mechanism.

### Fabric

**10 Year Limited Warranty** includes the Sunbrella awning & marine grade Fabric Collection. Visit [www.sunbrella.com/warranty](http://www.sunbrella.com/warranty) for more details. Note: Sunbrella Awning/Marine fabric is treated with a finish which gives the fabric its water repellency and a firmer hand which helps in the sewing and fabrication of the products. Mark-off/Crazing may appear as white scuff marks or thin white lines on the fabric which will normally diminish or go away with normal weathering and will not affect the overall performance of the product.

**5 Year Limited Warranty** applies to Glen Raven FİRESİST® and Sunbrella® furniture grade, Outdura® furniture grade and O'bravia® awning grade fabrics.

**What Is NOT Covered:** Failure caused by unreasonable or abusive use, or failure caused by neglect of reasonable and necessary care, and any modification to product are not covered by this warranty. We will only warranty products which are properly secured to an adequate base or mounting system and adhere to our required base weight minimums. Additionally, acts of nature (including but not limited to wind, hurricanes, tornadoes, and storms) are not covered by this warranty.

This warranty covers return freight of any warranted product only for the first year. This warranty gives you specific legal rights and you may have other rights which vary from state to state. If the powder coat finish flakes, bubbles, peels or loses color; Shademaker will re-finish or replace the defective bases at its discretion.

Closeout and promotional items sold by the dealer as is are not covered by this warranty. Labor charges are not covered under this limited warranty. Normal wear and tear is not covered under this limited warranty.

**Wind Damage:** Shademaker highly recommends that no umbrella, regardless of size or weight, ever be left unattended in the open position. In windy conditions, it is further recommended that umbrellas be closed, removed from their base, and stored or laid horizontally. This will reduce the risk of personal injury, damage to your umbrella, furniture, and other belongings or property. To ensure stability of your umbrella, please observe proper placement, and use sufficient base weight. This price list contains minimum recommendations for necessary weight for each style. Keep umbrella properly secured to umbrella base at all times. Thoroughly read and follow all provided instruction manuals.

Sufficient base weight must be used to secure umbrellas at all times. Please see individual product pages for recommended minimum weight requirements for free-standing applications. Using a Shademaker mount kit is always the preferred method of securing your umbrella above all other methods. We recommend a licensed contractor to secure your Shademaker umbrellas.

**Caution:** Seaside and indoor pool use, salt & chlorides can accumulate on the powder coat finish, leading to finish failure. Failure or neglect to make needed cleanings may cause paint to blister, and such failure will void limited warranty.

**Irregularities in Production Process:** The possibility of “Irregularities” in the product surface may occur during the production process. However, these irregularities do not reduce the quality of the product. Shademaker monitors every stage of production to ensure a clean and consistent appearance on every part.

**Rust:** Rust is a natural part of the aging process of all steel based materials and is therefore NOT considered a defect. Steel plate bases are designed to require minimum maintenance. Bases should be kept clean. Do not let dirt build up on the bases. Never leave bases standing in water. To keep your bases looking their best, you may wish to store them when not in use for an extended period of time.

**International Returns:** If an item is found to be under warranty Shademaker shall only be responsible for ground shipping charges to the location of the product within the continental United States and Canada. Any duties, express, international or special shipping charges are at the expense of the retail dealer or consumer.

#### **IMPORTANT RESTRICTION FOR PRODUCTS WARRANTY SERVICE:**

Shademaker restricts warranty service for products to the country where Shademaker or its authorized retail dealers originally sold the product. It is our policy to continuously improve designs, materials and manufacturing methods in order to provide you with the finest products. Therefore, variations in specifications, materials, prices, styles and finishes may be made without notice.

**NO RETURNS ON CUSTOM OR VALANCE UMBRELLAS. THE SELLER DISCLAIMS ANY IMPLIED WARRANTY OF MERCHANTABILITY.**

Those filing warranty claims outside 1 year or warranty, will be responsible for all shipping, handling, and freight charges on all claims to Shademaker in Baldwin Park, CA. All warranty claims must be submitted with the original proof of purchase, date of purchase, name of dealer, and the description of the damage. The Shademaker warranty is not transferable. Shademaker reserves the right to repair, replace, and/or redesign any product that is returned under a warranty claim.



13401 Brooks Drive  
Baldwin Park, CA 91706  
p 626.338.8810  
f 626.338.8816  
info@shademakerusa.com

**shademaker.com**

©2022 Shademaker. All rights reserved.

SMOM-ORI-122722